

**Specifications**

Nominal Voltage	6V	
Nominal Capacity(10hr)	200AH	
Dimension	Length	306±2mm(12.05inch)
	Width	168±2mm(6.61inch)
	Height	220±2mm(8.66inch)
	Total Height	222±2mm(8.74inch)
Approx Weight	Approx. 29.0kg(+ -3%)	
Terminal Type	M8	
container Material	ABS(UL-94HB)	
Internal Resistance	Approx.2.7mΩ	
Rated Capacity	202.0AH	(20hr, 1.70V/cell,25°C/77°F)
	200.0AH	(10hr, 1.75V/cell,25°C/77°F)
	175.0AH	(5hr, 1.75V/cell,25°C/77°F)
	150.0AH	(3hr, 1.70V/cell,25°C/77°F)
	110.0AH	(1hr, 1.60V/cell,25°C/77°F)
Max. Discharge Current	2000A(5S)	
Nominal Operating Temp. Range	25±3°C (77±5°F )	
Cycle Use	Charge Current Less Than 0.25CA	
	7.05V~7.35V@25°C(77°F)Temp. Coefficient -30mV/°C	
Floating Use	6.75V~6.9V@25°C(77°F)Temp. Coefficient -20mV/°C	
Capacity affected by Temperature	40°C	103%
	25°C	100%
	0°C	86%
	-15°C	65%
Self-discharge	3 month	Remaining capacity: 91%
	6 month	Remaining capacity:82%
	12month	Remaining capacity:65%

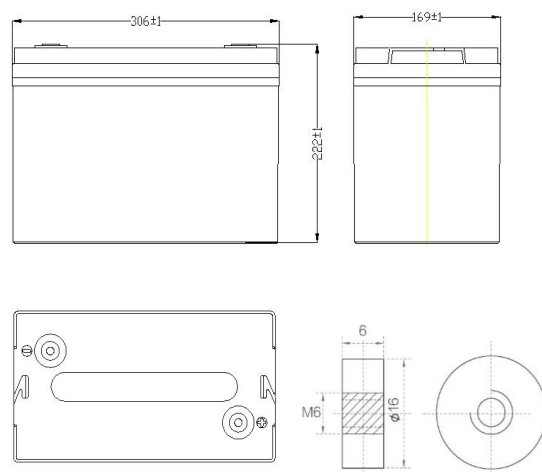

**Dimension**



Constant Power Discharge at 25°C(77°F)												
F.V/Time	5min	10min	15min	30min	1h	2h	3h	4h	5h	6h	10h	20h
1.80V/cell	1008	845	686	417	234	161.0	110.1	84.1	70.3	63.9	39.5	19.8
1.75V/cell	1023	855	696	432	239	162.9	111.1	84.9	70.4	64.5	39.5	20.0
1.70V/cell	1045	865	707	439	247	164.8	112.9	85.4	71.0	64.7	39.6	20.0
1.67V/cell	1057	872	718	449	257	166.8	113.5	86.0	71.1	65.0	39.6	20.0
1.60V/cell	1063	875	728	457	267	170	114.2	86.6	72.0	65.4	39.7	20.1

Constant Current Discharge at 25°C(77°F)												
F.V/Time	5min	10min	15min	30min	1h	2h	3h	4h	5h	6h	10h	20h
1.80V/cell	525	434	352	214	120	82.6	56.5	43.1	35.7	32.3	20.0	10.0
1.75V/cell	533	438	357	221	122	83.5	57.0	43.5	35.7	32.6	20.0	10.1
1.70V/cell	544	443	363	225	127	84.5	57.9	43.8	36.0	32.7	20.0	10.1
1.67V/cell	550	447	368	230	132	85.5	58.2	44.1	36.1	32.8	20.0	10.1
1.60V/cell	554	449	373	234	137	87.0	58.6	44.4	36.6	33.0	20.0	10.1

**Discharge Characteristics**

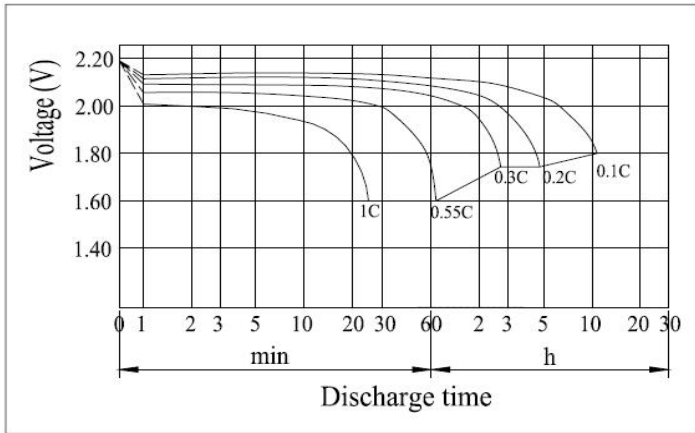

**Float Charging Characteristics**

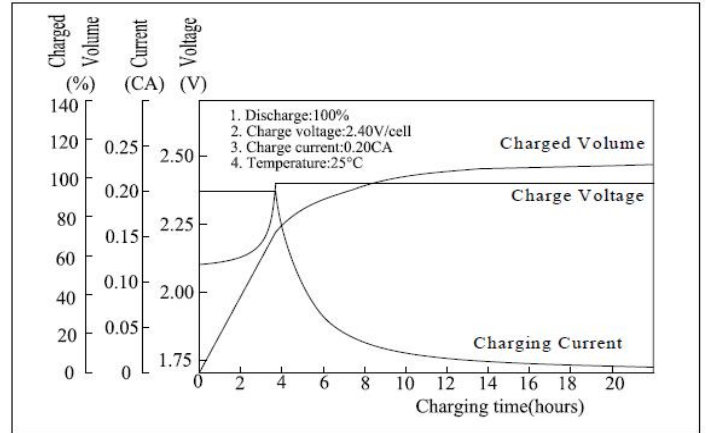

**Floating Life on Temperature**

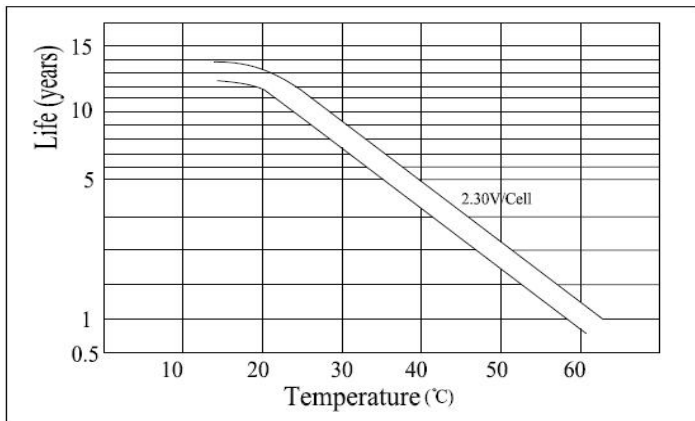

**Self Discharge Characteristics ( 25°C(77°F) )**

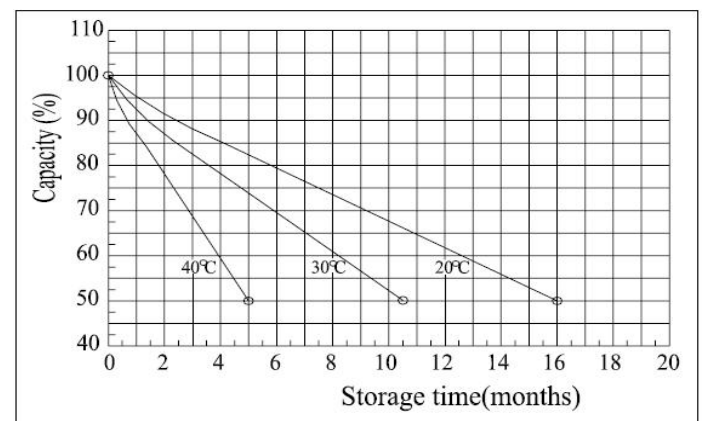

**Temperature Effects in Relation to Battery Capacity**

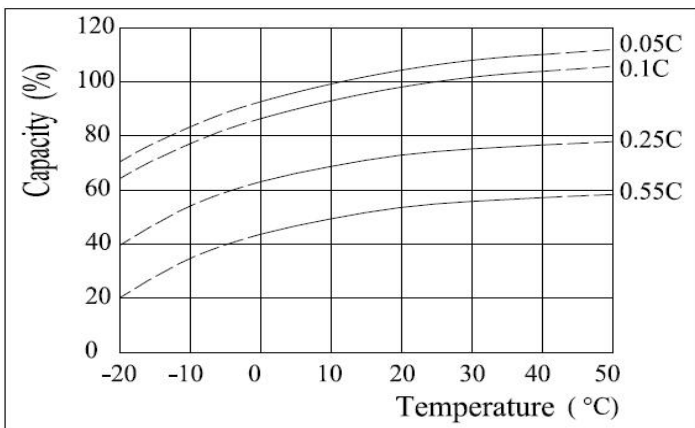

**Cycle Life Relation to Depth of Discharge**

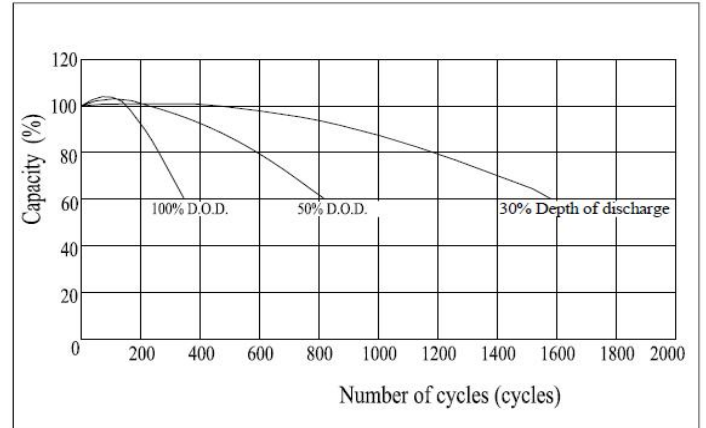

**Quanzhou Singlang Electric Technology Co., Ltd**

[www.xnb-battery.com](http://www.xnb-battery.com)

