

Specifications

Nominal Voltage	12V	
Nominal Capacity(10hr)	50AH	
Dimension	Length	230±2mm(9.06inch)
	Width	137±2mm(5.39inch)
	Height	210±2mm(8.27inch)
	Total Height	215±2mm(8.46inch)
Approx Weight	Approx. 16.1kg(+3%)	
Terminal Type	B4	
container Material	ABS(UL-94HB)	
Internal Resistance	Approx. 7.2mΩ	
Rated Capacity	52.40AH	(20hr, 1.75V/cell,25°C/77°F)
	50.00AH	(10hr, 1.75V/cell,25°C/77°F)
	43.65AH	(5hr, 1.75V/cell,25°C/77°F)
	39.24AH	(3hr, 1.75V/cell,25°C/77°F)
	26.97AH	(1hr, 1.75V/cell,25°C/77°F)
Max. Discharge Current	600A(5S)	
Nominal Operating Temp. Range	25±3°C (77±5°F)	
Cycle Use	Charge Current Less Than 0.25CA	
	14.1V~14.7V@25°C(77°F)Temp. Coefficient -30mV/°C	
Floating Use	No limit on Initial Charging Current Voltage	
	13.5V~13.8V@25°C(77°F)Temp. Coefficient -20mV/°C	
Capacity affected by Temperature	40°C	103%
	25°C	100%
	0°C	86%
	-15°C	65%
Self-discharge	3 month	Remaining capacity: 91%
	6 month	Remaining capacity: 82%
	12month	Remaining capacity: 65%

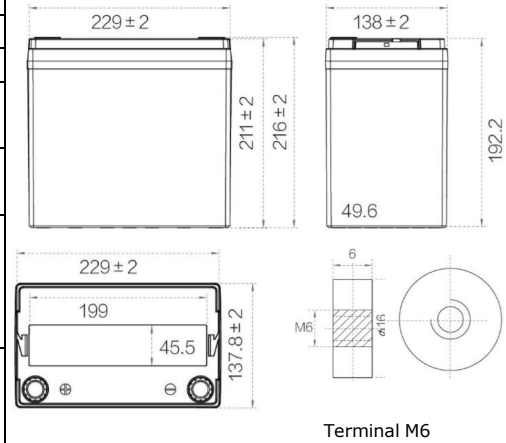

Dimensions



Constant Power Discharge at 25°C(77°F)

F.V/Time	5min	10min	15min	30min	1h	2h	3h	4h	5h	6h	10h	20h
1.80V/cell	300.4	204.4	139.9	85.1	52.1	32.55	25.30	19.90	16.87	11.27	9.70	5.07
1.75V/cell	303.0	206.1	141.1	85.8	52.6	32.82	25.51	20.07	17.00	11.36	9.85	5.15
1.70V/cell	310.5	211.2	144.7	88.0	53.9	33.64	26.15	20.57	17.43	11.65	9.99	5.23
1.67V/cell	318.1	216.4	148.2	90.1	55.2	34.46	26.79	21.07	17.86	11.93	10.14	5.30
1.60V/cell	332.3	226.1	154.8	94.1	57.7	35.99	27.98	22.01	18.66	12.47	10.29	5.38

Constant Current Discharge at 25°C(77°F)

F.V/Time	5min	10min	15min	30min	1h	2h	3h	4h	5h	6h	10h	20h
1.80V/cell	154.0	104.8	71.8	43.64	26.74	16.69	12.98	10.21	8.65	5.78	4.93	2.58
1.75V/cell	155.3	105.7	72.4	44.01	26.97	16.83	13.08	10.29	8.73	5.83	5.00	2.62
1.70V/cell	159.2	108.3	74.2	45.11	27.64	17.25	13.41	10.55	8.95	5.97	5.07	2.66
1.67V/cell	163.1	111.0	76.0	46.21	28.32	17.67	13.74	10.81	9.15	6.12	5.15	2.70
1.60V/cell	170.3	115.9	79.4	48.27	29.57	18.46	14.35	11.28	9.56	6.39	5.22	2.73

Discharge Characteristics

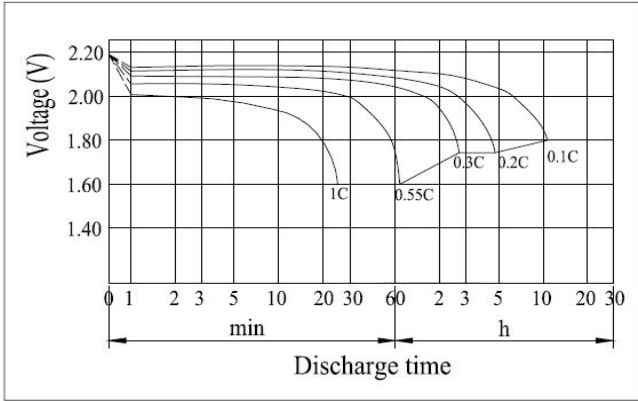

Float Charging Characteristics

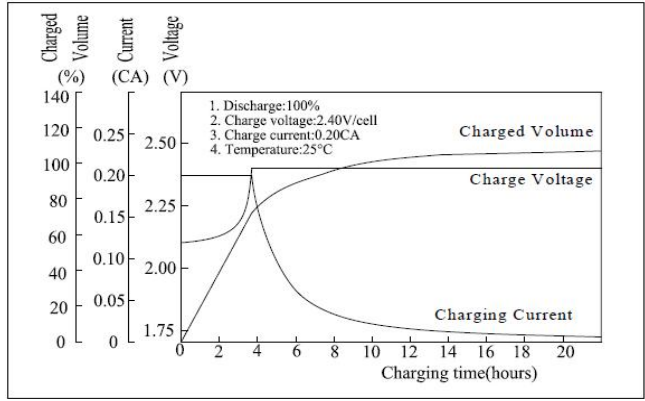

Floating Life on Temperature

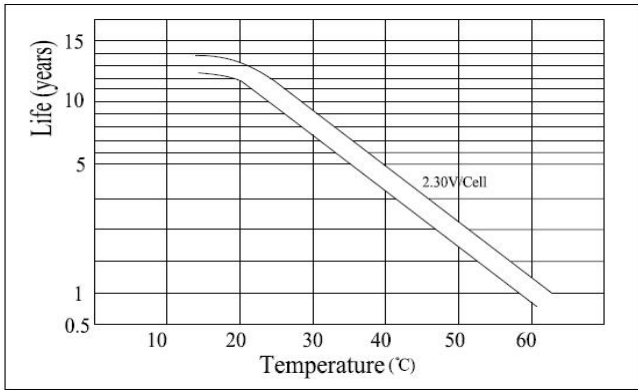

Self Discharge Characteristics (25°C(77°F))

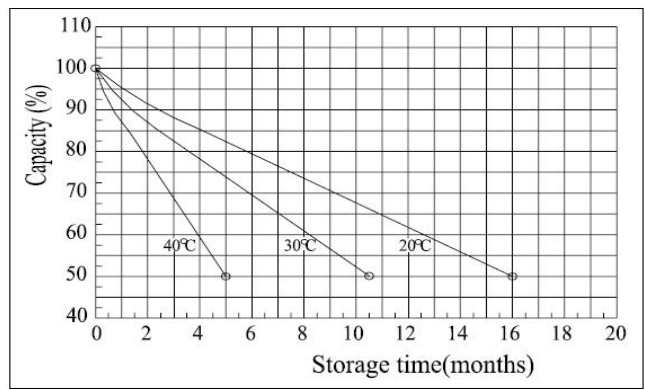

Temperature Effects in Relation to Battery Capacity

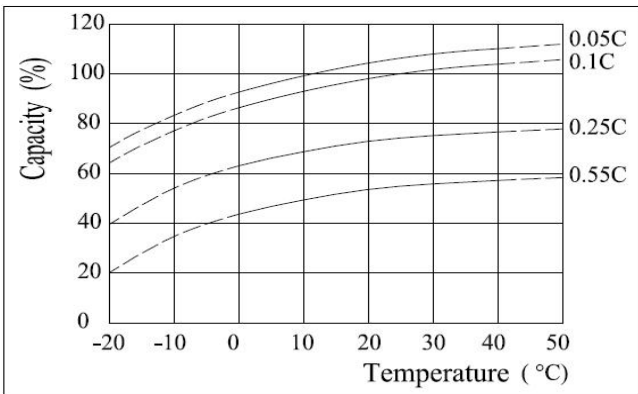

Cycle Life Relation to Depth of Discharge

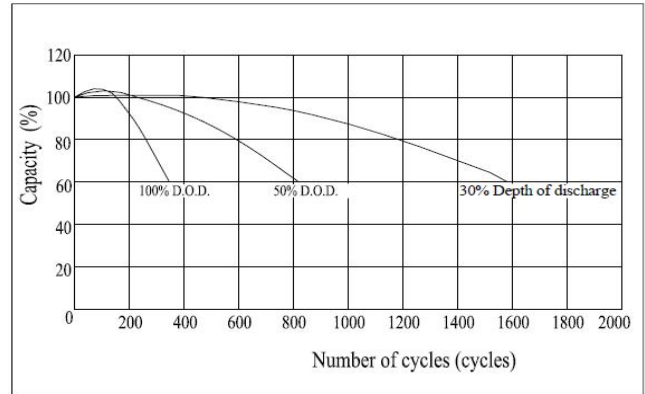

Quanzhou Singlang Electric Technology Co., Ltd
www.xnb-battery.com

